

Article number: 01020371

Description: Retaining ring J20 DIN472  
Stainless 411

## Measures

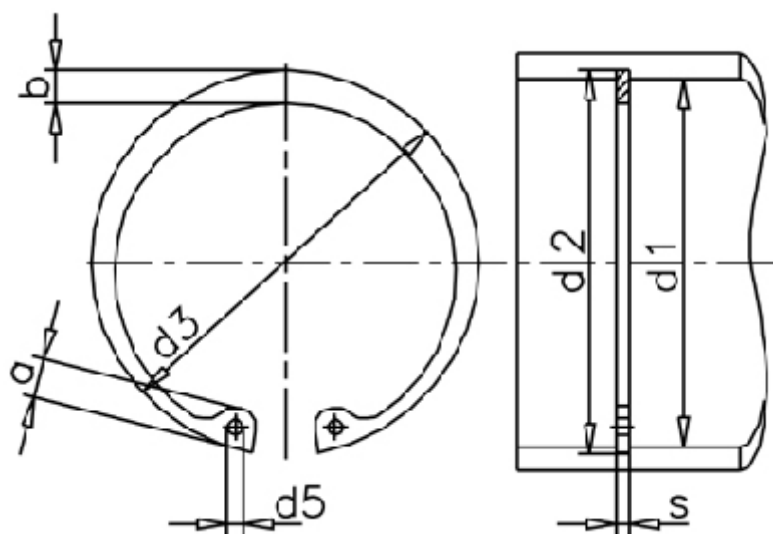

a max	= 4.1	FN kN	= 5.40	t	= 0.50
AN mm <sup>2</sup>	= 32.2	FRg kN	= 2.6	tol	= +0,13
b	= 2.3	FR kN	= 7.2	tol	= +0,42-0,13
d1	= 20	g	= 1.0	tol	= -0.06
d2	= 21.0	K kN-mm	= 16.9	Tong	= ZGJ-2
d3	= 21.50	m min	= 1.10	Weight kg/1000	= 0.90
d5 min	= 2.0	Nominal drive	= 1.5		
Description	= J 20	s	= 1.00		